

# Bacs pour vitrines à glaces

## BACS

Modèles	BACS FABRIQUÉS EN ACIER INOXYDABLE POLI						
	BAC 5	BAC 7	BAC 9	BAC 5 (h80)	BAC 8	BAC 10	BAC 13
Référence	2FMR9100	2FMR9150	2FMR9200	2FMR9750	2FMR9225	2FMR9250	2FMR9300
PPC	22 €	29 €	30 €	26 €	32 €	41 €	42 €
	BAC 12	BAC 14	BAC 1/4	BAC 7 (carré)	BAC 5 (triangulaire-AE/AI 45°)	BAC 2,5	
Référence	2FMR9350	2FMR9400	2FMR9700	2FMR9600	2FIS9763	2FMR9015	
PPC	48 €	64 €	21 €	52 €	79 €	21 €	
	BACS TRANSPARENTS FABRIQUÉS EN POLYCARBONATE*						
	BAC TRANS 5	BAC TRANS 5 (h 80)					
Référence	2FIS9751	2FIS9752					
PPC	29 €	34 €					
			Accessoires		TIM/H18 pour bac 165x165		
			Référence		2FMR9010		
			PPC		28 €		

\*Uniquement modèles GelatoShow



Bacs en acier inox. 5 et 7 l de capacité.



Bacs en acier inox. 10 et 12 l de capacité.



Exposition et réserve de glace en vitrine, avec bac 5 l.

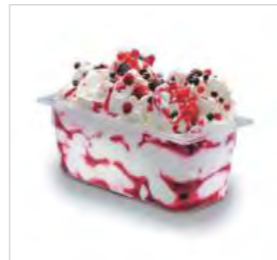

Bacs transparents fabriqués en polycarbonate (Gelatoshow).

### Caractéristiques techniques

Modèles	A	B	C
Bac inox 5	360	165	120
Bac inox 7	360	165	150
Bac inox 9	360	165	180
Bac inox 5 l	360	250	80
Bac inox 10 l	360	250	120
Bac inox 12 l	360	250	150
Bac inox 16 l	360	250	180
Bac inox 12	420	200	150
Bac inox 14	420	200	200
Bac inox 1/4	260	160	150
Bac inox 2,5	165	165	120
Bac inox 7 (carré)	210	200	200
Bac triangulaire (45°)	360	145/185	120
Bac trans, 5	360	165	120
Bac trans 5 (h 80)	360	250	80

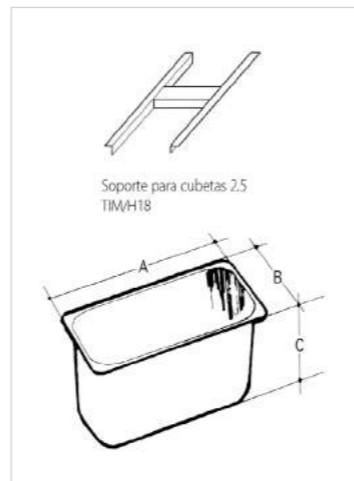

Nous nous réservons le droit de modifier les modèles et les données techniques.

### BACS POUR VITRINES À GLACES

#### ISETTA

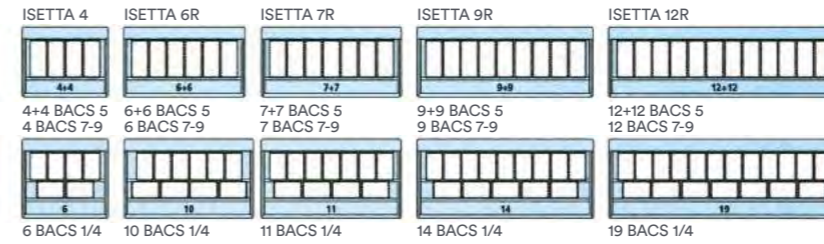

#### ISABELLA LX

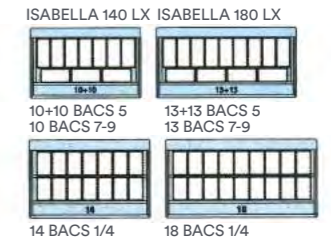

#### FIJI

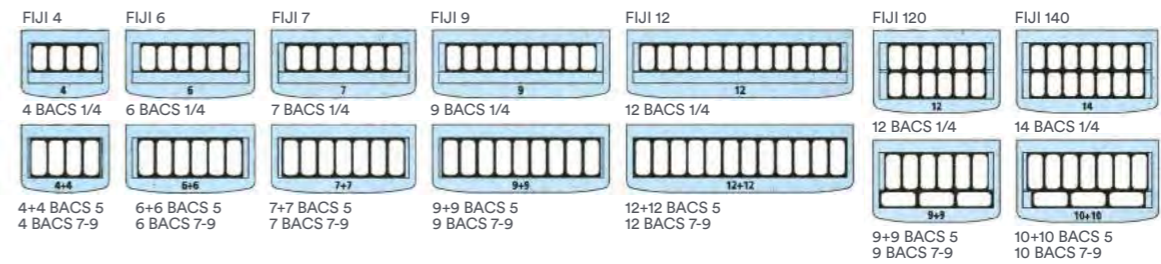

#### NEW MILLENNIUM SP



#### DIVA

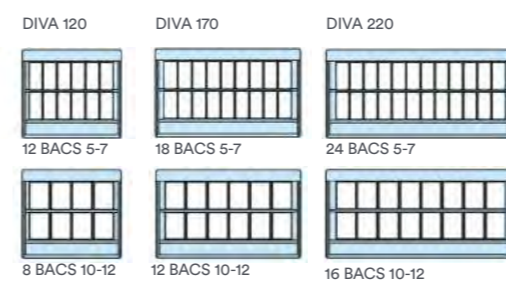

#### BERMUDA

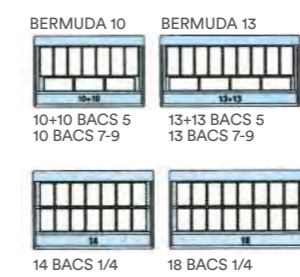

#### CARRETINO

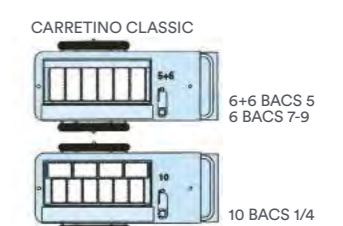

#### KALEIDO

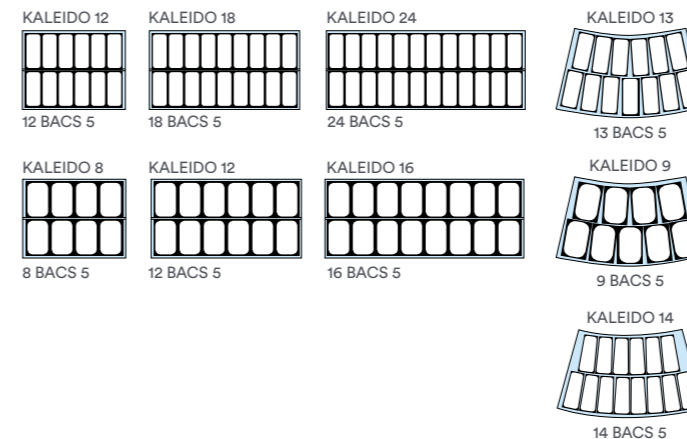

#### OLÍMPICA

